

Parts Manual
PL70-1068EN
01/20/2014

Cleco®

22 Series Double Reduction Three Stage Rotary Vane Power Motors



For additional product information visit our website at <http://www.apextoolgroup.com>



Zampini Industrial Group
AirToolPro.com
1-800-353-4676

Industrial Air & Electric Tools
We Sell Reliability!
In Business Since 1987
FREE Expert Assistance - Call Now

Cleco® Nomenclature

| Model Number | Maximum Allowable RPM | | Stall Torque | | Weight | | Overall Length | | Air Consumption | | Gear Ratio | Exhaust |
|---|-----------------------|------------|--------------|-------|--------|------|----------------|-----|-----------------|--------|------------|---------|
| | @ Max. HP | Free Speed | ft. lbs. | Nm | lbs. | kg | in. | mm | cfm | m3/min | | |
| Round Housing - Reversible - 1/2" Diameter Keyed Spindle (only) | | | | | | | | | | | | |
| 22-5070-50 | 165 | 330 | 28.4 | 38.48 | 2.75 | 1.25 | 7.88 | 200 | 29 | 0.82 | 50.4:1 | Side |
| Flange and Base Mounting - Reversible - 1/2" Diameter Keyed Spindle (only) | | | | | | | | | | | | |
| 22M5070-50 | 165 | 330 | 28.4 | 38.48 | 3.06 | 1.39 | 7.88 | 200 | 29 | 0.82 | 50.4:1 | Side |
| 22M5071-50 | 250 | 500 | 19.6 | 26.56 | 3.06 | 1.39 | 7.88 | 200 | 29 | 0.82 | 3.48:1 | Side |
| 22M5072-50 | 350 | 700 | 13.5 | 18.29 | 3.06 | 1.39 | 7.88 | 200 | 29 | 0.82 | 24:1 | Side |

Termination Options Models:

- 01 Series 200 Collet Chuck (for milling and routing)
- 38 0"-1/4" Capacity Drill Chuck
- 51 1/16"-3/8" Capacity Drill Chuck
- 53 5/64"-1/2" Capacity Drill Chuck
- 60 1/2"-20 Threaded Spindle
- 62 Series "K" Collet Chuck (for milling and routing)

The original language of this manual is English.

Product Safety Information:

Intended Use:

This pneumatic power motor is to be used only as a power source to be integrated into an application or machine.

For additional product safety information refer to Apex Tool Group, LLC or Apex Tool Group GmbH & Co. OHG document CE-2005, General Safety Instructions Air Motors.



The power motor must not be modified in any manner unless approved in writing by Apex Tool Group, LLC or Apex Tool Group GmbH & Co. OHG. All safety devices must be properly installed and maintained in good working order.

EC Declaration of Conformity:

No data available on this equipment.

Noise and Vibration:

No data available on this equipment.

Air Line Lubrication:

Use Apex Tool Group, LLC or Apex Tool Group GmbH & Co. OHG's lightweight air tool oil 500021 (available in quantities shown in the following chart) or an SAE-5 lightweight spindle oil.

| Part No. | Packaged | Designation |
|----------|--------------------------|-------------------------|
| 540397 | 1 Quart (0.94 liter) | Airlube 10W/NR-420LB DR |
| 533485 | 1 US Gallon (3.78 liter) | Airlube 10W/NR-420LB DR |

Air Supply Line:

| Parameter | Description |
|------------------------|---|
| Air Hose | Air inlet: 1/4" (6,4 mm) 5/16" I.D. Air Hose: Maximum length run of 10.0' (3 m) 3/8" I.D. Air Hose: Runs over 10.0' (3 m) |
| Working pressure range | 60 to 100 psi (414 to 689 kPa) Recommended: 90 psi (620 kPa) |
| Compressed air | Air quality according to ISO 8573-1, quality class 2.4.3 The compressed air must be clean and dry. |

Service and Repair:

Tool service and repair should be performed by an authorized Apex Tool Group, LLC or Apex Tool Group GmbH & Co. OHG Center. Refer to the last page of this manual for locations.

Disposal:



Observe local disposal guidelines for all components of this tool and its packaging.

Copyright Protection:

Apex Tool Group, LLC or Apex Tool Group GmbH & Co. OHG reserves the right to modify, supplement or improve this document or the product without prior notice. This document may not be reproduced in any way, shape or form, in full or parts thereof, or copied to another natural or machine readable language or to a data carrier, whether electronic, mechanical, optical or otherwise without the express permission of Apex Tool Group, LLC or Apex Tool Group GmbH & Co. OHG

“A”

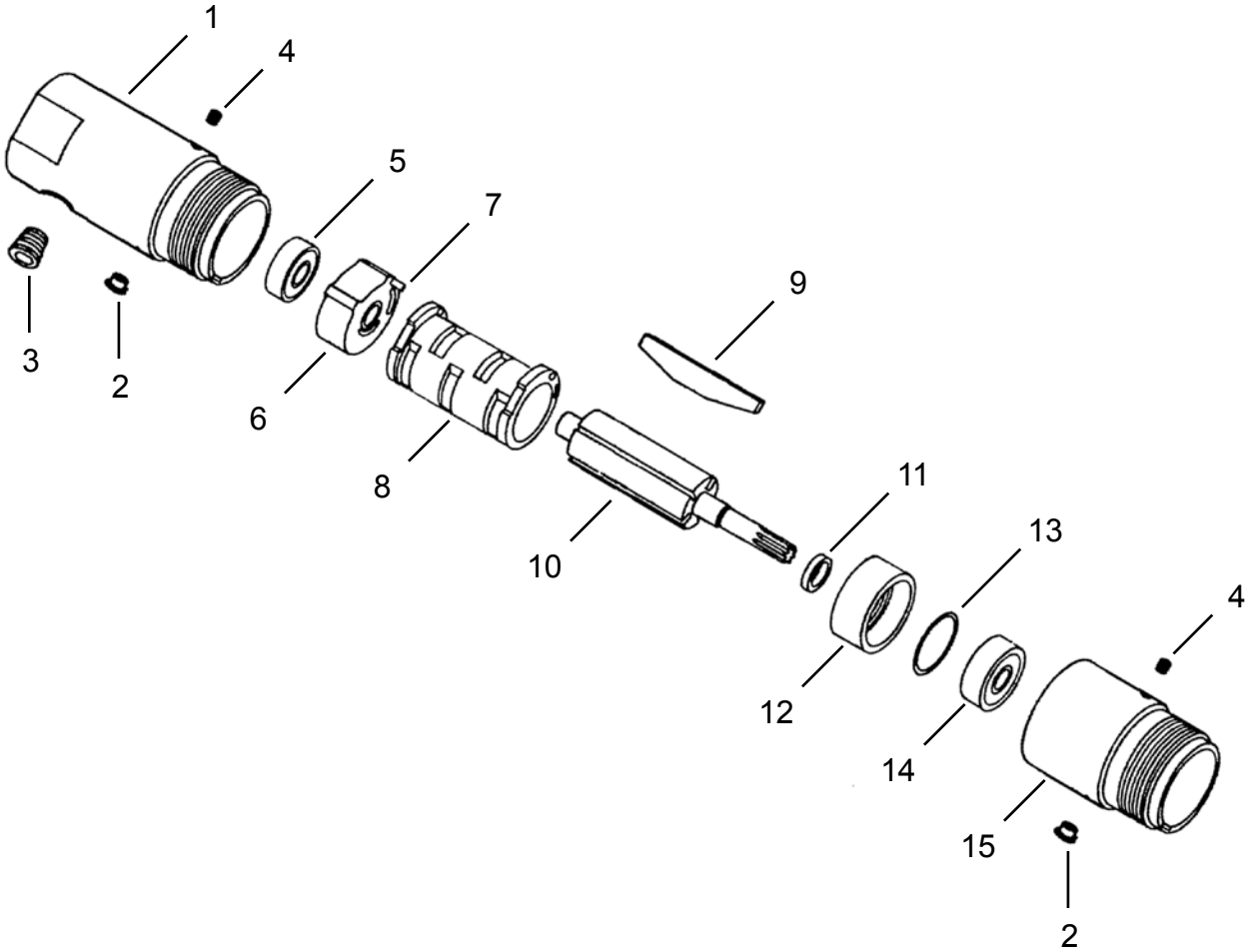

Illustration "A": Motor Assembly

| Ref | Number | # | X | EN |
|-----|---------|---|---|------------------------------------|
| | | | | Description |
| 1 | 02-7131 | 1 | | Motor Housing (includes 1 Ref. 2) |
| 2 | 1664 | 2 | 4 | Grease Fitting |
| 3 | 2957 | 2 | 4 | Pipe Plug (1/4-18 NPTF) |
| 4 | 2831 | 2 | 4 | Set Screw (#10-32) |
| 5 | 538PT | 1 | 2 | Ball Bearing |
| 6 | 7061PT | 1 | | Bearing Plate (includes Ref. 7) |
| 7 | 1041 | 1 | 2 | Pin |
| 8 | 7099PT | 1 | | Cylinder |
| 9 | 2906 | 4 | 8 | Rotor Blade |
| 10 | 7656S | 1 | | Rotor (includes Ref. 11) |
| 11 | 2017PT | 1 | | Rotor Spacer |
| 12 | 2959 | 1 | | Bearing Plate |
| 13 | 2488PT | 1 | 2 | Shim Packet |
| 14 | 500PT | 1 | 2 | Ball Bearing |
| 15 | 2720PT | 1 | | Center Housing (includes 1 Ref. 2) |

(#) Quantity

(X) Recommended Spare Parts (quantity shown based on 1-5 tools in operation)

Cleco®
Gearing Assembly

"B"

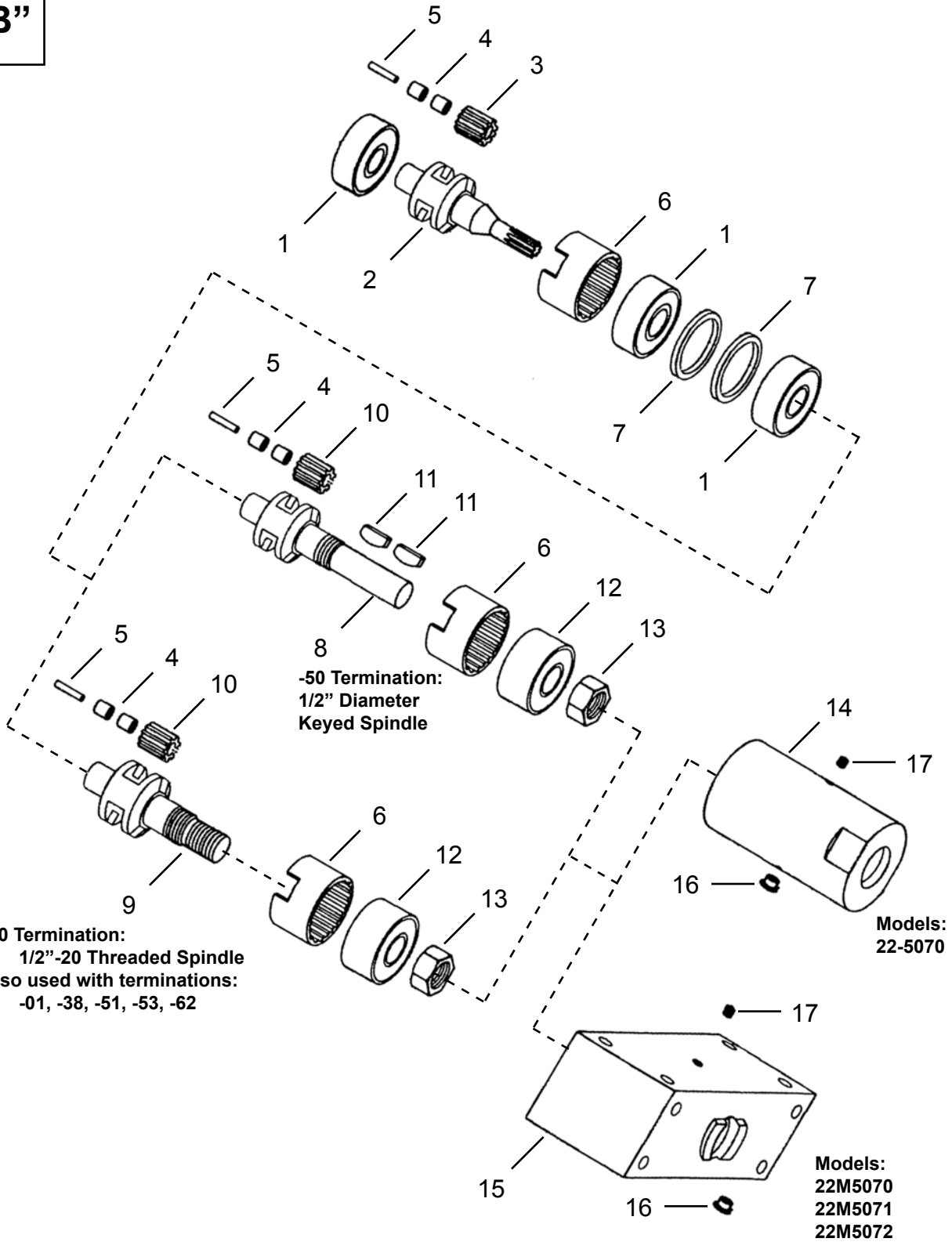

Illustration "B": Gearing Assembly

| Ref | Number | # | X | EN | |
|-----------------------|-----------|---|----|---|--|
| | | | | Description | |
| 1 | 556 | 3 | 6 | Ball Bearing | |
| 2 | Table "B" | 1 | | Planetary Gear Carrier | |
| 3 | Table "B" | 2 | 4 | Planetary Gear (includes 2 Ref. 4) | |
| 4 | 1464 | 8 | 16 | Planetary Gear Needle Bearing | |
| 5 | 2509PT | 4 | 8 | Planetary Gear Shaft | |
| 6 | 2533PT | 2 | | Ring Gear | |
| 7 | 2022PT | 2 | | Bearing Spacer | |
| 8 | 2927 | 1 | | Planetary Gear Carrier (-50 Termination) | |
| 9 | 2513PT | 1 | | Planetary Gear Carrier (-01, -62 Terminations) | |
| | 2864 | 1 | | Planetary Gear Carrier (-38, -51, -53, -60 Terminations) | |
| 10 | Table "B" | 2 | 4 | Planetary Gear (includes 2 Ref. 4) | |
| 11 | 613 | 2 | 4 | Woodruff Key (-50 Termination) | |
| 12 | 557 | 1 | 2 | Double Ball Bearing | |
| 13 | 2958 | 1 | 1 | Lock Nut | |
| 14 | 2893 | 1 | | Round Planetary Housing (includes Ref. 16) | |
| 15 | 2819PT | 1 | | Flange and Base Mounting Planetary Housing (includes Ref. 16) | |
| 16 | 1664 | 1 | 2 | Grease Fitting | |
| 17 | 2831 | 1 | 2 | Set Screw | |
| Termination 60 | | | | | |
| -- | 14-0812 | 1 | 2 | Wrench (3/4") (not shown) | |

(#) Quantity

(X) Recommended Spare Parts (quantity shown based on 1-5 tools in operation)

Table "B"

| Ref. | Description | # | 22-5070 22M5070 | # | 22M5071 | # | 22M5072 |
|------|------------------------|---|--------------------|---|--------------|---|------------|
| 2 | Planetary Gear Carrier | 1 | 2851 | 1 | 2848 | 1 | 2848 |
| 3 | Planetary Gear | 2 | 2809PT (17T) | 2 | 2809PT (17T) | 2 | 2956 (15T) |
| 10 | Planetary Gear | 2 | 2809PT (17T) | 2 | 2956 (15T) | 2 | 2956 (15T) |

(T) Teeth

Cleco® Optional Terminations

“B”

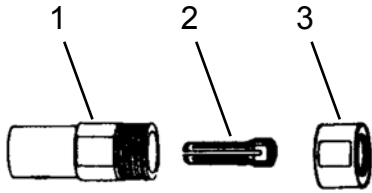

-01 Termination: Series 200 Collet

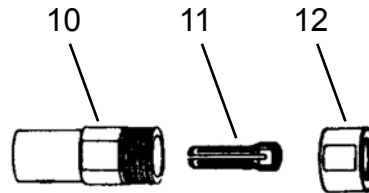

-62 Termination: Series “K” Collet

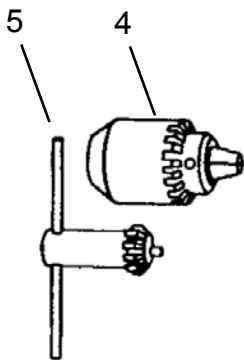

-38 Termination: 1/4” Drill Chuck

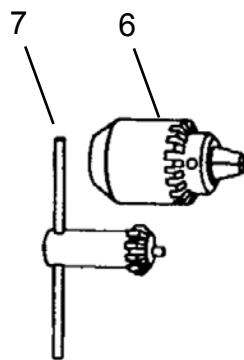

-51 Termination: 3/8” Drill Chuck

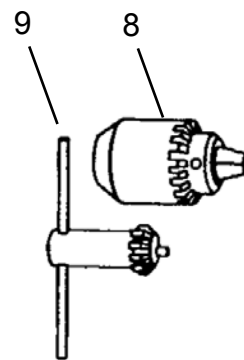

-53 Termination: 1/2” Drill Chuck

Illustration "C": 22 Series Motor Terminations

| Ref | Number | # | X | EN |
|---|----------|---|---|-----------------------------|
| | | | | Description |
| Termination 01 - Series 200 Collet | | | | |
| 1 | 2801PT | 1 | 2 | Collet Chuck Body |
| 2 | 208 | 1 | 2 | 1/4" Collet |
| 3 | 2058PT | 1 | 2 | Collet Cap |
| -- | 14-0809 | 1 | 2 | Wrench (9/16") (not shown) |
| -- | 14-0812 | 1 | 2 | Wrench (3/4") (not shown) |
| Termination 38 - 0"-1/4" Drill Chuck Capacity | | | | |
| 4 | 14-2545B | 1 | 1 | 1/4" Chuck |
| 5 | 14-2548 | 1 | 2 | Chuck Key |
| Termination 51 - 1/16"-3/8" Drill Chuck Capacity | | | | |
| 6 | 14-2546 | 1 | 1 | 3/8" Chuck |
| 7 | 14-2169 | 1 | 2 | Chuck Key |
| Termination 53 - 5/64"-1/2" Drill Chuck Capacity | | | | |
| 8 | 14-2547 | 1 | 1 | 1/2" Chuck |
| 9 | 14-2549 | 1 | 2 | Chuck Key |
| Termination 62 - Series "K" Collet | | | | |
| 10 | 14-2254 | 1 | 2 | Collet Chuck Body |
| 11 | 124PT | 1 | 2 | 1/4" Collet |
| 12 | 4255PT | 1 | 2 | Collet Cap |
| -- | 14-0814 | 1 | 2 | Wrench (7/8") (not shown) |
| -- | 14-0818 | 1 | 2 | Wrench (1-1/8") (not shown) |

(#) Quantity

(X) Recommended Spare Parts (quantity shown based on 1-5 tools in operation)



Zampini Industrial Group
AirToolPro.com
1-800-353-4676

Industrial Air & Electric Tools
We Sell Reliability!
In Business Since 1987
FREE Expert Assistance - Call Now



Zampini Industrial Group
AirToolPro.com
1-800-353-4676

Industrial Air & Electric Tools
We Sell Reliability!
In Business Since 1987
FREE Expert Assistance - Call Now

Sales & Service Centers

Note: All locations may not service all products. Please contact the nearest Sales & Service Center for the appropriate facility to handle your service requirements.

Detroit, Michigan

**Apex Tool Group
Sales & Service Center**
2630 Superior Court
Auburn Hills, MI 48326
Tel: (248) 393-5640
Fax: (248) 391-6295

Houston, Texas

**Apex Tool Group
Sales & Service Center**
6550 West Sam Houston
Parkway North, Suite 200
Houston, TX 77041
Tel: (713) 849-2364
Fax: (713) 849-2047

Lexington, South Carolina

Apex Tool Group
670 Industrial Drive
Lexington, SC 29072
Tel: (800) 845-5629
Tel: (803) 951-7544
Fax: (803) 358-7681

Los Angeles, California

**Apex Tool Group
Sales & Service Center**
6881 Stanton Avenue
Unit B
Buena Park, CA 90621
Tel: (714) 994-1491
Fax: (714) 994-9576

Seattle, Washington

**Apex Tool Group
Sales & Service Center**
2865 152nd Avenue N.E.
Redmond, WA 98052
Tel: (425) 497-0476
Fax: (425) 497-0496

York, Pennsylvania

**Apex Tool Group
Sales & Service Center**
3990 East Market Street
York, PA 17402
Tel: (717) 755-2933
Fax: (717) 757-5063

Brazil

**Apex Tool Group
Sales & Service Center**
Av. Liberdade, 4055
Zona Industrial - Iporanga
18087-170 Sorocaba
SP Brazil
Tel: +55 15 2383929
Fax: +55 15 2383260

Canada

**Apex Tool Group
Sales & Service Center**
7631 Bath Road
Mississauga, Ont. L4T
3T1
Canada
Tel: (866) 691-6212
Tel: (905) 673-4400

China

Cooper (China) Co., Ltd.
an Apex Tool Group, LLC
company
955 Sheng Li Road,
Heqing Pudong, Shanghai
China 201201
Tel: +86-21-28994176
Fax: +86-21-51118446

England

**Apex Tool Group
GmbH & Co. OHG**
C/O Spline Gauges
Piccadilly, Tamworth
Staffordshire B78 2ER
United Kingdom
Tel: +44 1827 8741 28
Fax: +44 1827 8741 28

France

Apex Tool Group S.N.C.
25 rue Maurice Chevalier
B.P. 28
77831 Ozoir-La-Ferrière
Cedex, France
Tel: +33 1 64 43 22 00
Fax: +33 1 64 43 17 17

Germany

**Apex Tool Group
GmbH & Co. OHG**
Industriestraße 1
73463 Westhausen
Germany
Tel: +49 (0) 73 63 81 0
Fax: +49 (0) 73 63 81 222

Hungary

**Apex Tool Group
Hungaria Kft**
Platánfa u.2
9027 Győr
Hungary
Tel: +36 96 66 1383
Fax: +36 96 66 1135

India

**Apex Power Tools India
Private Limited**
Gala No. 1, Plot No. 5
S. No. 234, 235 & 245
Indialand Global
Industrial Park
Taluka-Mulsi, Phase I
Hinjawadi, Pune 411057
Maharashtra, India

Mexico

**Apex Tool Group México
S. de R.L. de C.V.**
Vialidad El Pueblito #103
Parque Industrial Querétaro
Querétaro, QRO 76220
Mexico
Tel: +52 (442) 211-3800
Fax: +52 (442) 103-0443

Apex Tool Group, LLC
1000 Lufkin Road
Apex, NC 27539
Phone: 919-387-0099
Fax: 919-387-2614
www.apextoolgroup.com

Cleco®